

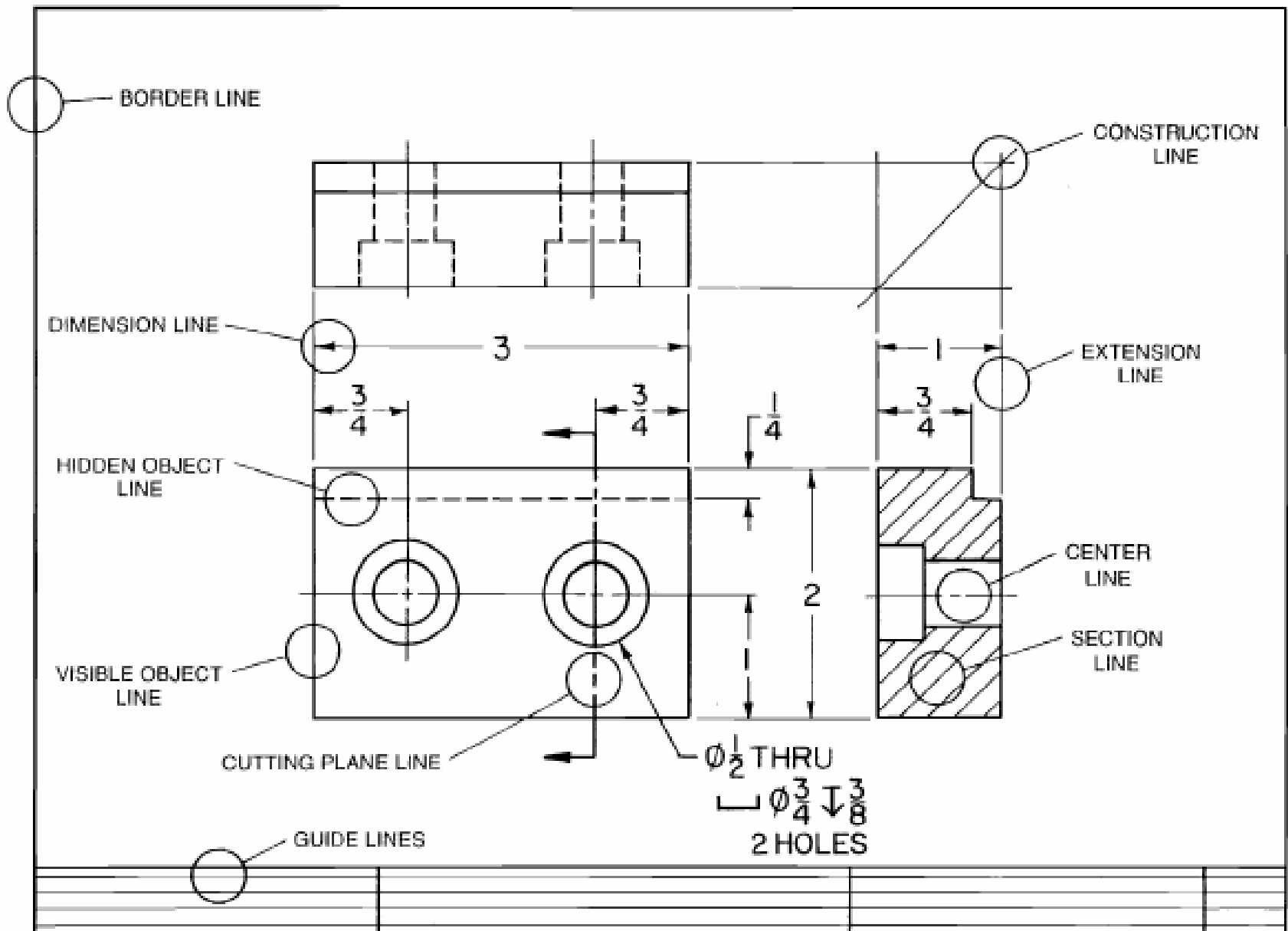

SKETCHING

How the Alphabet of Lines is Used



ALPHABET OF LINES

1) LETTERING ALL UC, USE GUIDELINES

2) DASHES TOO LONG

3) REPEAT THE PATTERN

4) INCONSISTENT SPACING OR WRONG SPACING

5) MEASURE SPACING \perp TO LINES

6) LINES NOT \parallel

7) DRAW, DON'T ERASE, TO MAKE GAPS

8) LINEWORK TOO BOLD, SHOULD BE THINNER

9) LINEWORK TOO LIGHT

10) WRONG LINETYPE

11) WRONG ANGLE

12) 3MM HIGH TEXT

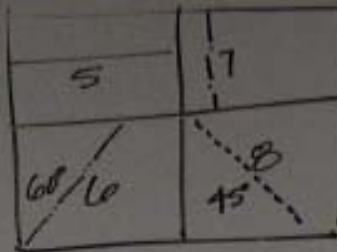

INDICATES
CORRECT -
TRY TO
DUPLICATE

14) DON'T ERASE - REDRAW
ON A FRESH TITLEBLOCK

15) SHARPEN & ROTATE PENCIL

16) SLOPPY !!

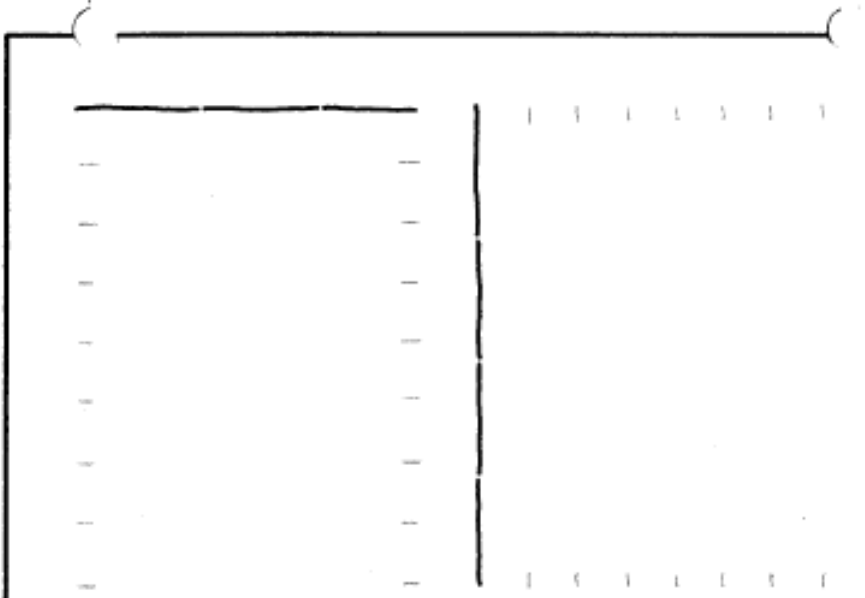

SKETCH HORIZONTAL AND VERTICAL LINES

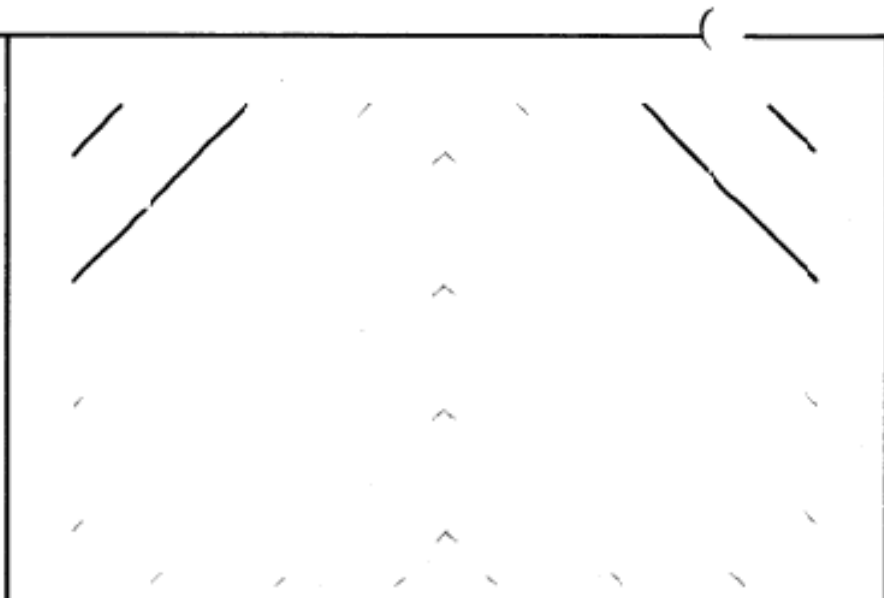

SKETCH ANGULAR LINES

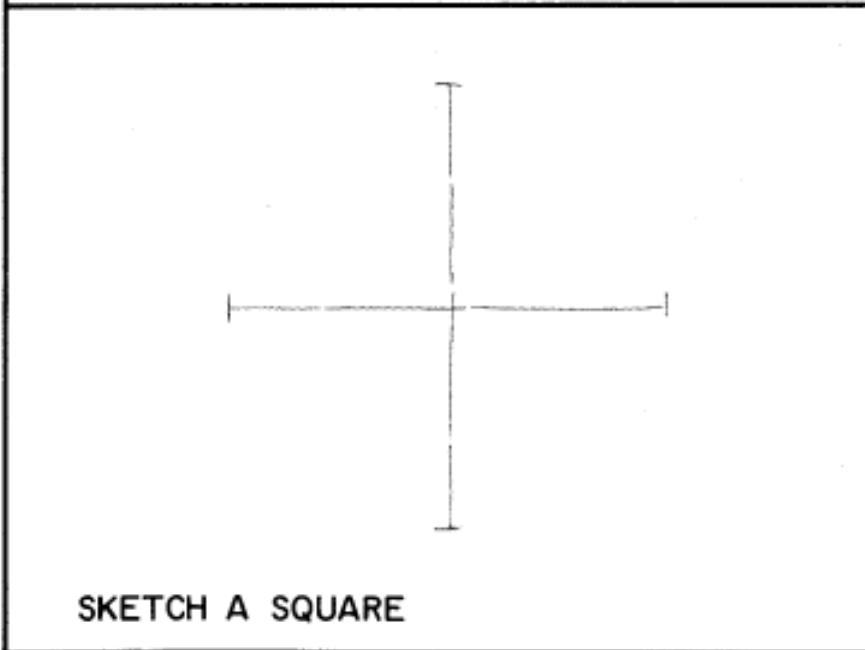

SKETCH A SQUARE

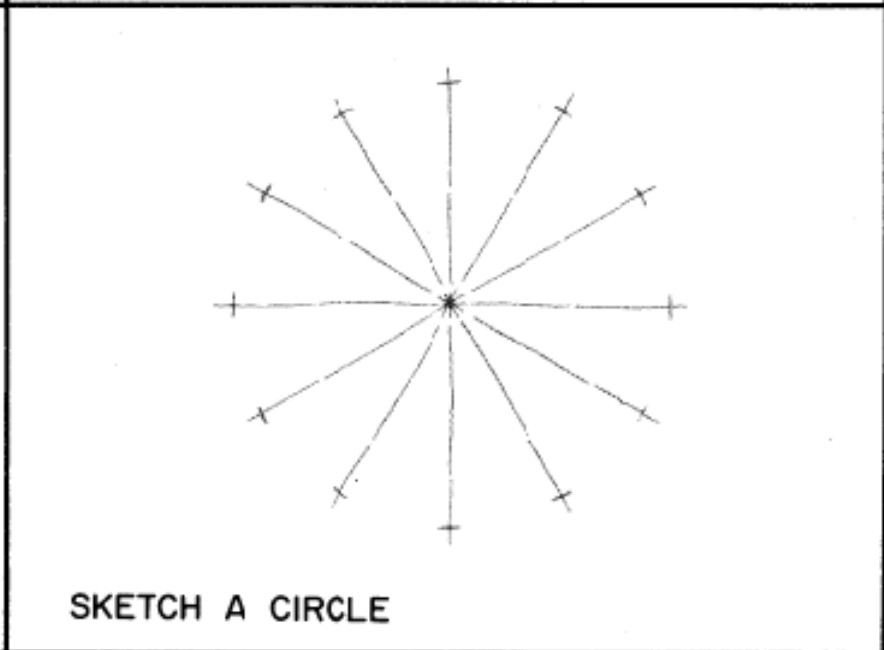

SKETCH A CIRCLE

NAME

PERIOD

DATE

PLATE 3-IA

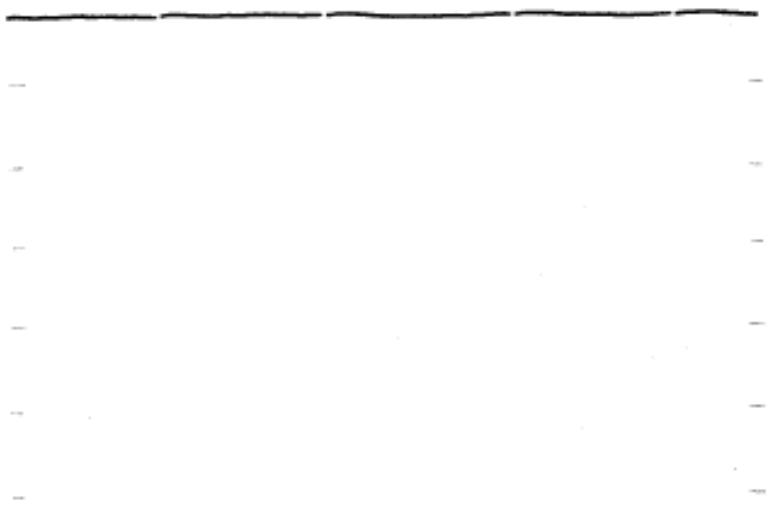

SKETCH HORIZONTAL LINES



SKETCH VERTICAL LINES



SKETCH ANGULAR LINES



SKETCH ANGULAR LINES

NAME

PERIOD

DATE

PLATE 3-IB

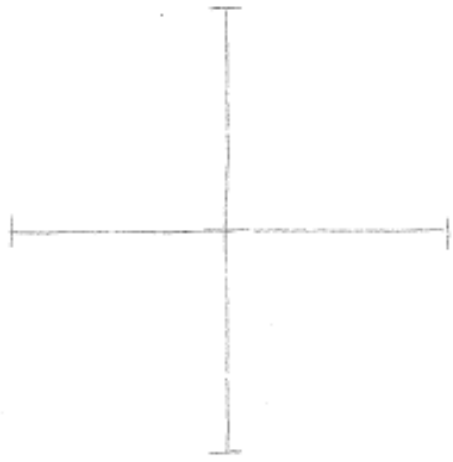

SKETCH A SQUARE



SKETCH A 45° ANGLE



SKETCH A 30°-60° ANGLE

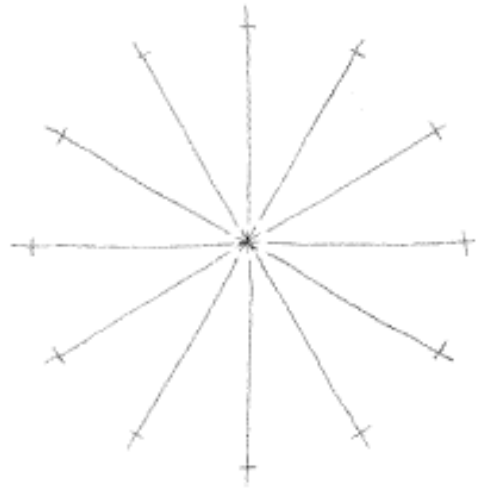

SKETCH A CIRCLE

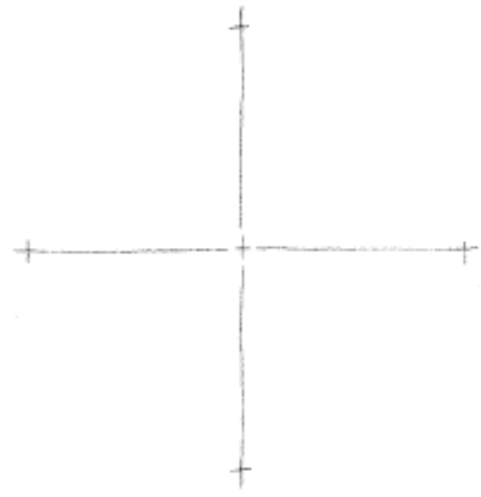

SKETCH AN OCTAGON

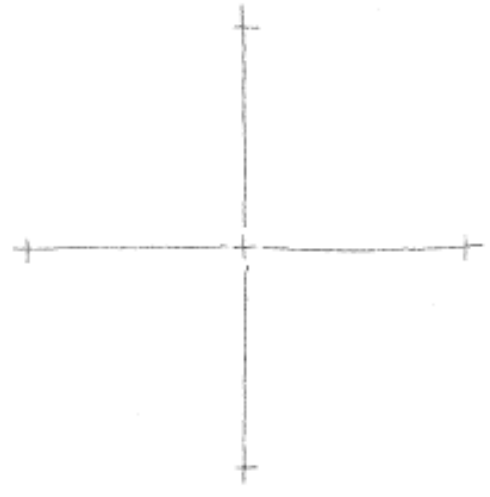

SKETCH A HEXAGON



VISIBLE LINE



HIDDEN LINE



CONSTRUCTION LINE



DIMENSION LINE



CENTER LINE



BORDER LINE



SECTION LINE



CUTTING PLANE LINE



PHANTOM LINE

PROBLEM - SKETCH THE ALPHABET OF LINES

NAME

PERIOD

DATE

PLATE 3-2

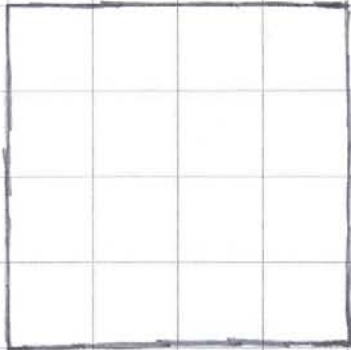

SQUARE

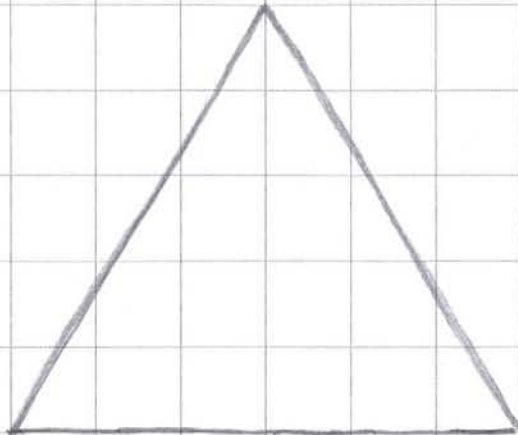

TRIANGLE

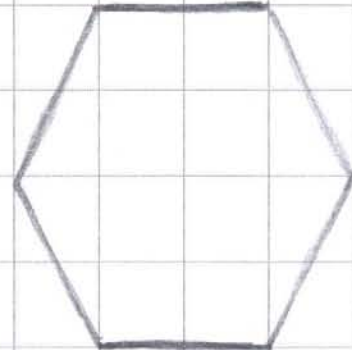

HEXAGON

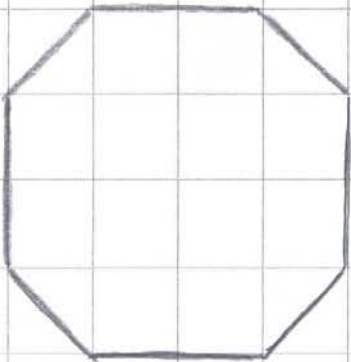

OCTAGON

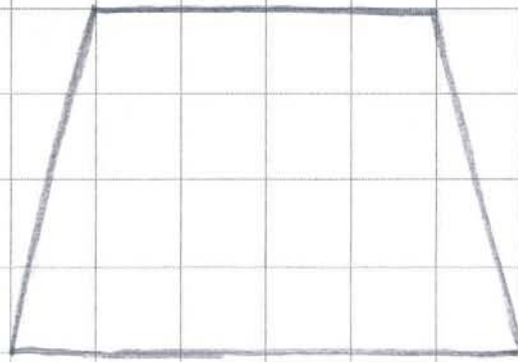

TRAPEZOID

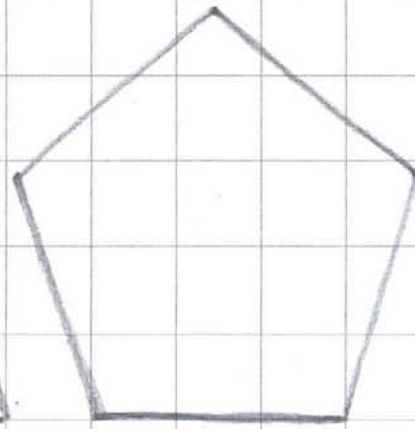

PENTAGON

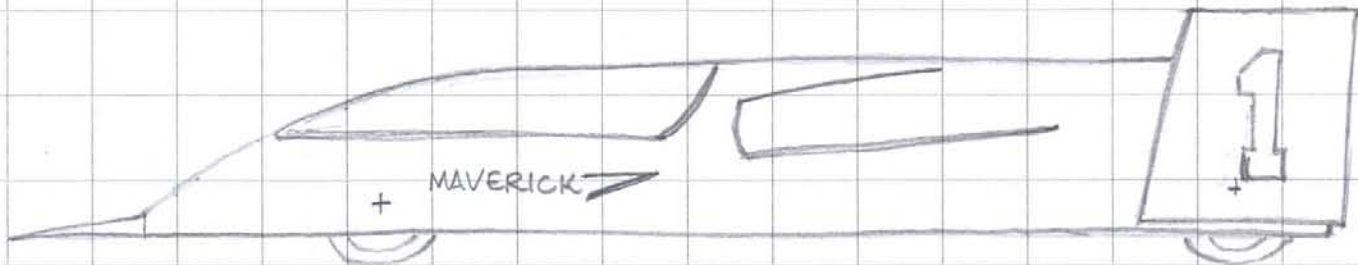

MAVERICK - MACH 2 LAND RACER

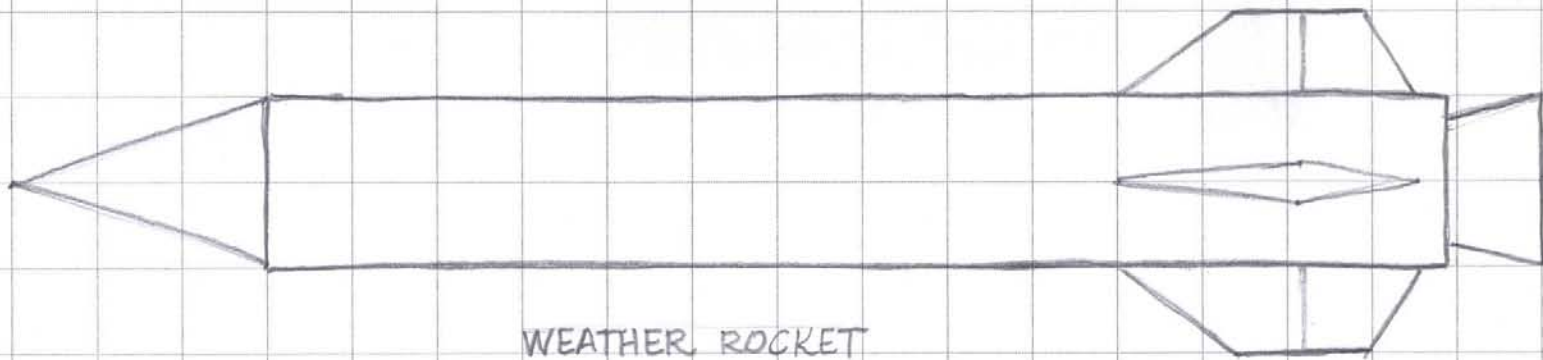

WEATHER ROCKET

HERITAGE HIGH SCHOOL
BRENTWOOD, CALIFORNIA

SKETCHING

MR. BEHLING
15 JANUARY 2008

3-1 B

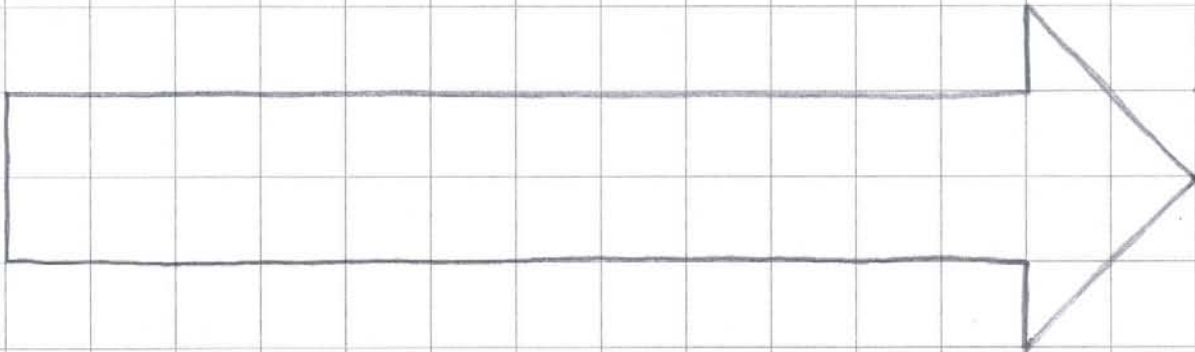

DIRECTION ARROWS

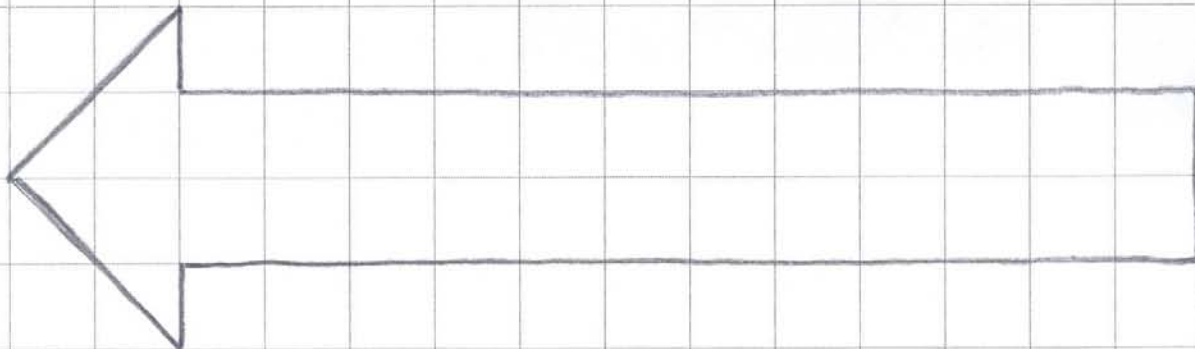

HERITAGE HIGH SCHOOL
BRENTWOOD, CALIFORNIA

SKETCHING

MR. BEHLING
15 JANUARY 2008

3-10

10

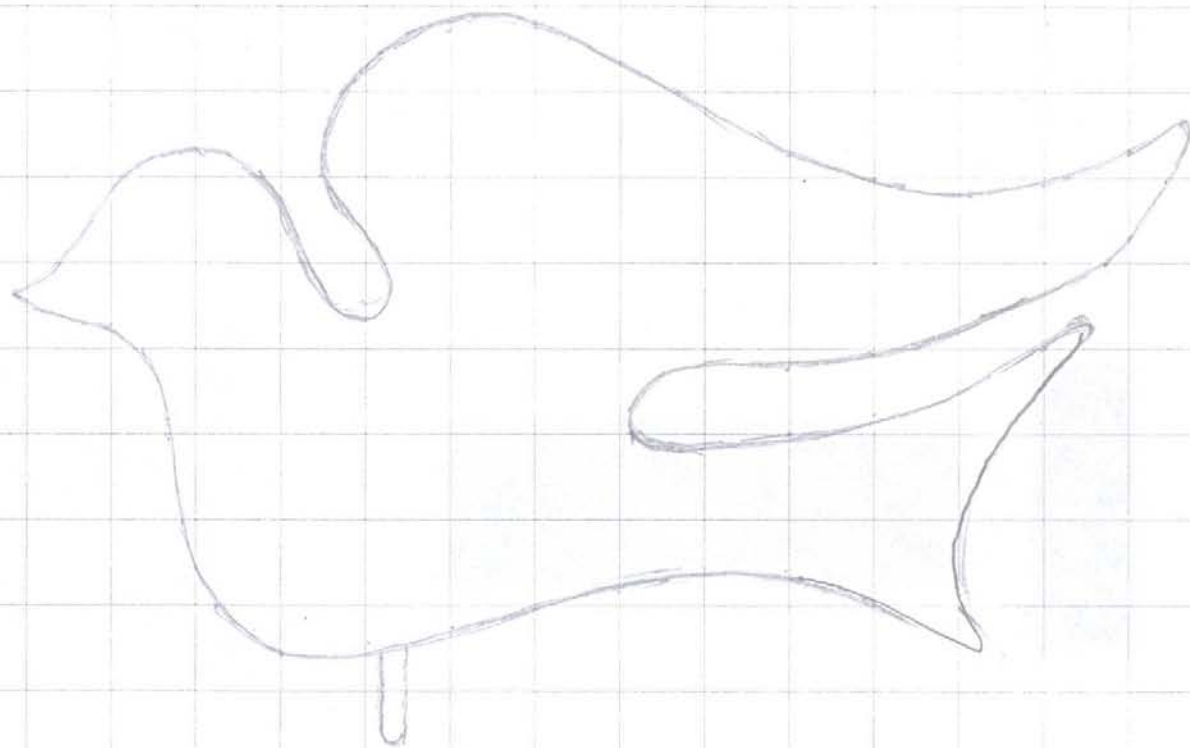

EARLY AMERICAN WEATHERVANE

HERITAGE HIGH SCHOOL
BRENTWOOD, CALIFORNIA

SKETCHING

MIR. BEALING
22 JANUARY 2009

3-10

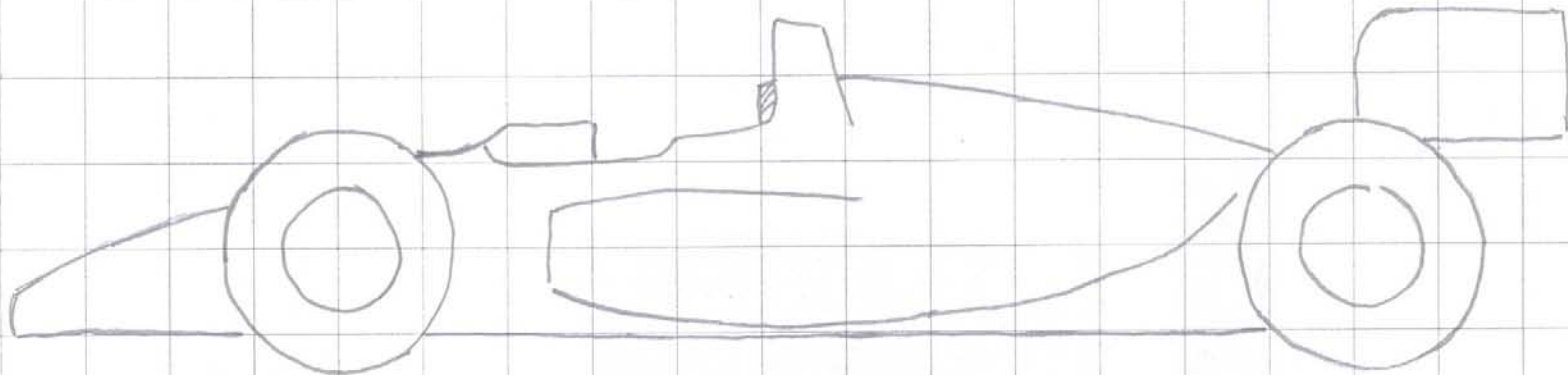

FREEDOM HIGH SCHOOL

OAKLEY, CALIFORNIA

SKETCHING

MR. BETLING

FALL 2009

3-1E